

What is SEG

**SEG (Silicone Edge Graphics)
fabric graphics with a
revolutionary finishing
technique for all extrusion
based display systems.**

What is SEG FAQ



What is SEG (Silicone Edge Graphics)?

SEG is a high-resolution dye-sublimated fabric graphic finished with a thin silicone strip (or welt/gasket). The silicone strip is sewn directly to the edge of the graphic, and the strip is then inserted into a frame with a recessed groove. The size of the graphic must be precise so the fabric is taut when installed in the frame. The result is a large format graphic that mimics the old fashioned hard panel graphics commonly found on custom displays and interior spaces.

What is different or special about SEG?

- **Superior Fabric.** The fabric is from only high quality vendors.
- **Versatile.** SEG can be used on many extrusion profiles.
- **Quality.** The fabric undergoes a painstaking pre-inspection

before the images are printed.

- **Dye-Sublimation.** Dye-sublimation graphics are durable, vibrant, and lightweight.
- **Less Frame.** SEG graphics are the perfect choice when more graphic and less frame is desired.
- **No Sew Line.** Unlike bead or pole pocket finished graphics, the sew line is hidden within the extrusion providing a more finished look to your exhibit or retail wall display.

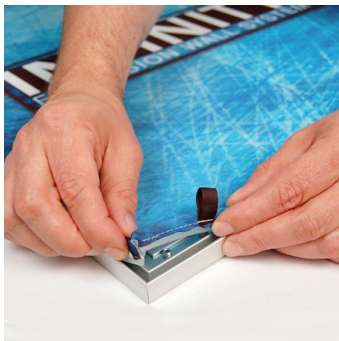

What are the benefits of SEG?

- **Storage and Shipping.** Fabric is lighter than many other graphics. When folded neatly, fabric graphics take up much less space than traditional direct print graphics.
- **Care.** Fabric graphics can be washed and steamed and are just as durable and long lasting as traditional graphics.
- **Lightweight.** Larger graphics weigh less, perfect for draping or creating space definition.
- **Cost.** More image bang for the buck!
- **Green.** There are the obvious transportation and storage benefits. Even more exciting is the growing list of fabric options created from recycled materials.
- **No Glare.** Fabric is the perfect choice for media walls or any backdrop that is being photographed or video recorded.
- **Versatility.** SEG fabric can be applied to most displays or event structures.
- **Less Visible Frame.** The silicone edge means you see more graphic and less frame.

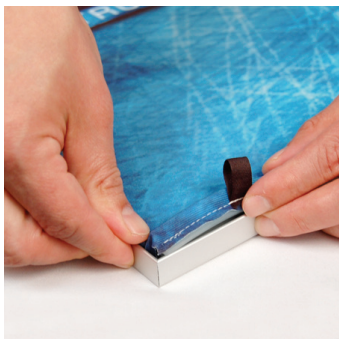

What is SEG FAQ

What are the size limits of SEG?

- The maximum size (without a seam) of an SEG graphic is about 118" (117" visual).
- Larger seamed graphics are available.

Why customers love SEG graphics

1. Tight as a drum, vivid, flat fabric graphics replace hard panel graphics in custom displays.
2. Highest quality look.
3. Neatly finished corners.
4. More visible graphic, less frame.
5. Pull tabs applied for easy material removal from frame.
6. Quick install and even faster break down.
7. Improved storage, drayage, and shipping costs with fabric graphics.



Do fabric graphics offer the same color saturation, vibrancy, definition, and overall image quality as other graphics?

Fabric not only matches other graphic options, it often exceeds it! Dye sublimation equipment is more advanced than ever offering near continuous tone (limited by the texture of the material you choose) and exceptional detail created from high dpi outputs and sophisticated image patterns. Color is permanently dyed into the fabric creating a deep saturated image.

How should fabric graphics be cared for?

It is recommended that graphics be folded and stored in a bag. You may spot clean by wiping with a damp cloth. If it is necessary to wash the graphic and it is small enough, use a commercial size front-loading washing machine. Wash on the gentle cycle, with cool water. Dry cleaning is NOT recommended.

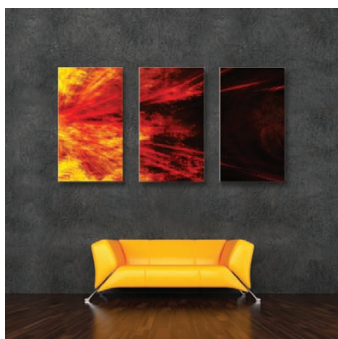

What is SEG FAQ

To limit getting the graphic dirty during installation, keep the set-up area clean by using a drop cloth and wash your hands prior to setup. You may want to consider purchasing inexpensive white cotton gloves. Wearing the gloves while handling the graphic will minimize the transfer of dirt and oils to your graphic.

What is the preferred file set-up for SEG?

We keep up with the most current Adobe Creative Suite available.

Preferred file formats: Adobe Illustrator EPS, Adobe Photoshop PSD, TIFF, EPS

Alternate file formats: Adobe InDesign INDD, INX, QuarkXpress QXD.

Additional Note: Quark and in some instances InDesign, will not retain photo cropping information when exporting file as an eps to open in Illustrator. When file links are updated your photos will not relink correctly. Please provide a viewable pdf file for any art created in InDesign or Quark. Documents are still requested for the print file, not pdf or eps.

Work in full size when possible, however you may set your artwork up at any size as long as it scales proportionately to the final dimensions. When setting up files in photoshop, resolution should be at 100ppi at final size. For example, if you wish to set up your artwork at a quarter size of the final dimension and your final dimensions are 72" w x 96" h, then your art at quarter size will be 18" w x 24" h @ 400ppi.

Additional Art Preparation Tips

- Adding 1" of bleed to files will help our Digital Imaging department when setting up files to print. Make sure to note when bleed is added so we know whether to crop or scale down artwork.
- Zoom in on line art to check all points and intersections. Too many points can make the art look like straight lines make up the curves. Similar to laying down matchsticks to make a circle.
- When creating a gradient, avoid using stepped blends because the maximum number of steps allowed in Illustrator may band on large format graphics. Using the linear and radial gradient options will produce the best output.
- Scan across Photoshop print file at 100% at full size to check for dirt, specs, hairs, and spots.
- Avoid using auto trace options or making clipping paths using magic wand selections. These typically are not clean and smooth. Taking the time to draw your paths will produce the best outcome.
- If you have specific colors you would like matched, do not use a transparency or opacity feature to achieve a certain color. Instead, assign a color value or use a tint.

What is standard turnaround time for SEG?

Typical turnaround time is per customer request. Larger jobs require more production time and should be scheduled accordingly.



What is SEG FAQ

Extrusion Profiles Shown at Actual Size

Extrusion frames we are able to create SEG graphics for:

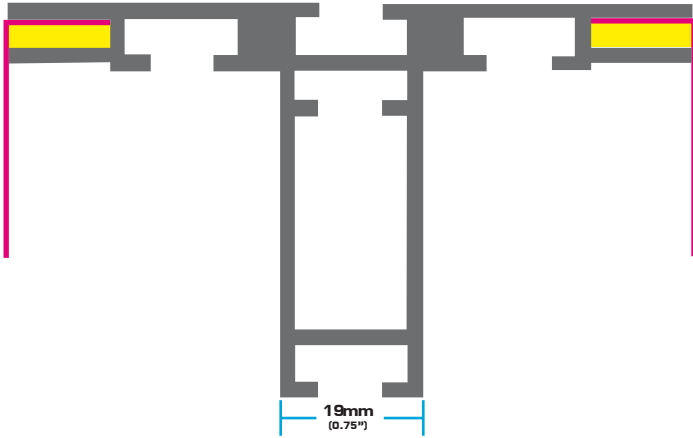

Classic MODUL®
Double sided capability
TSP 50

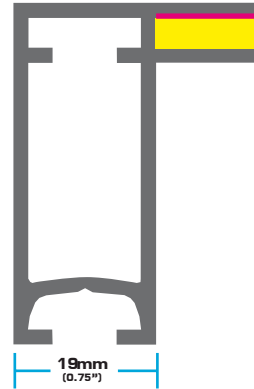

Classic MODUL®
Double sided capability
TSP 46

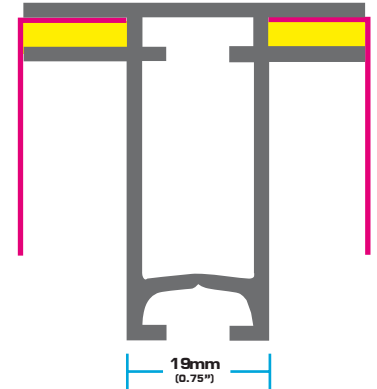

Classic MODUL®
Double sided capability
TSP 49

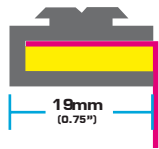

Classic MODUL®
Double sided capability
TSP 3

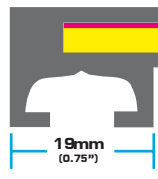

Classic MODUL®
Double sided capability
TSP 10



Classic MODUL®
Double sided capability
TSP 47

Extrusion frames carried in stock:

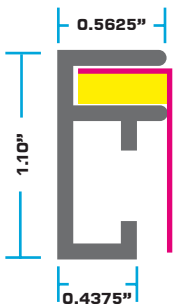

Infinity™
Single sided only

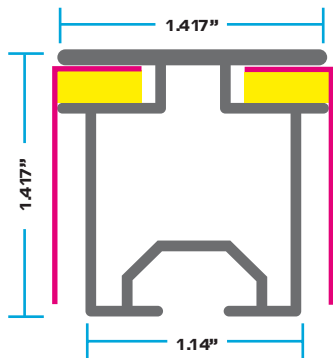

Nouveau™
Double sided capability
Mer-CT-4200

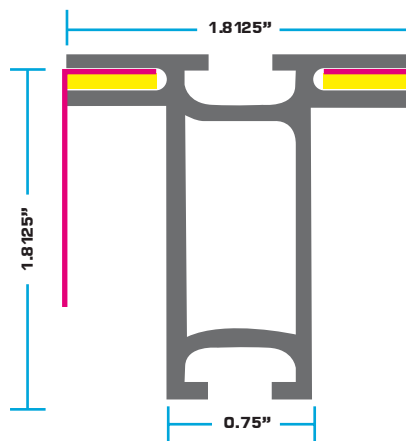

Agam®
Double sided capability
FH452

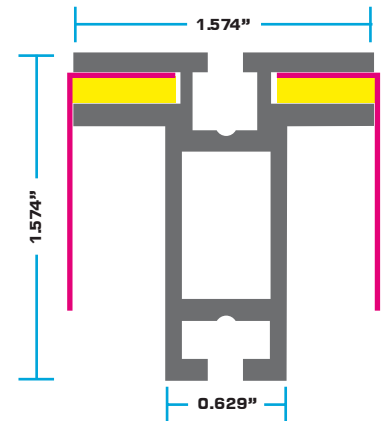

Octanorm®
Double sided capability
M1307

Fabric graphic

Extrusion frame

SEG {silicone edged graphics}

Silicone Edge Graphics



What is SEG FAQ

Determining Opening Size:
Measure from outer edge of SEG graphic channel to opposite outer edge of SEG graphic channel.

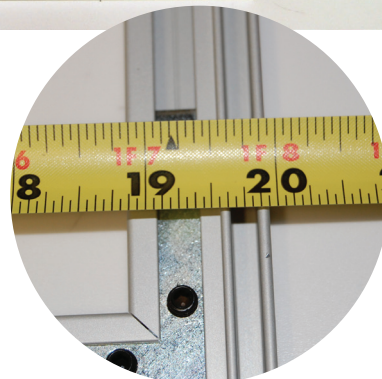
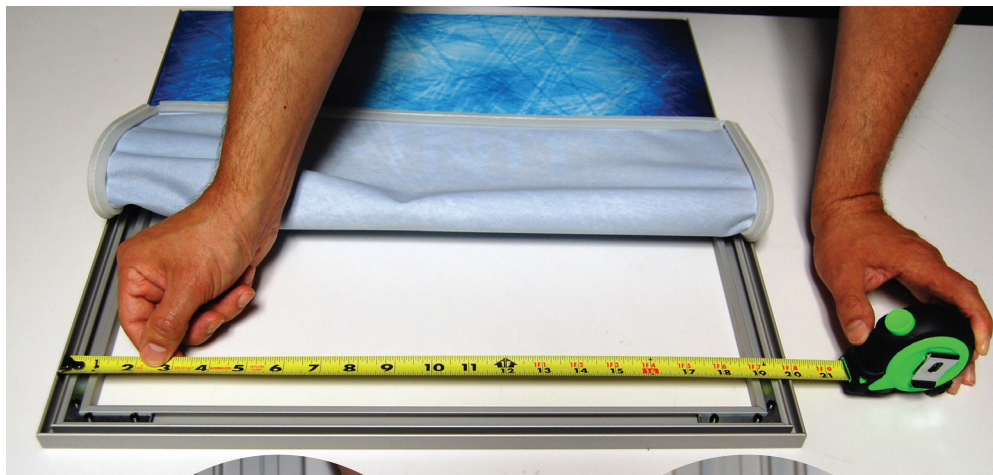
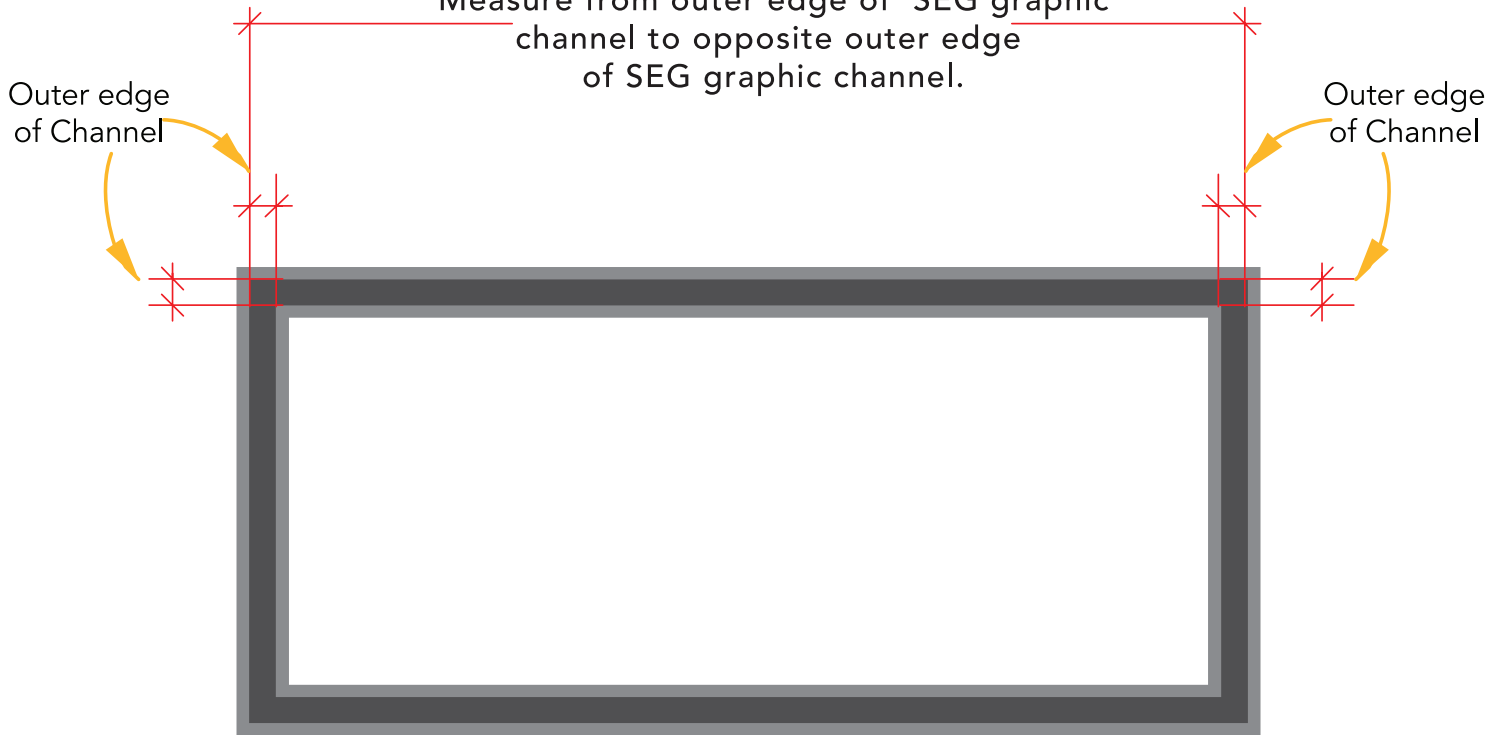

What is SEG **FAQ** ?

Proper installation of an SEG graphic in an extrusion frame.

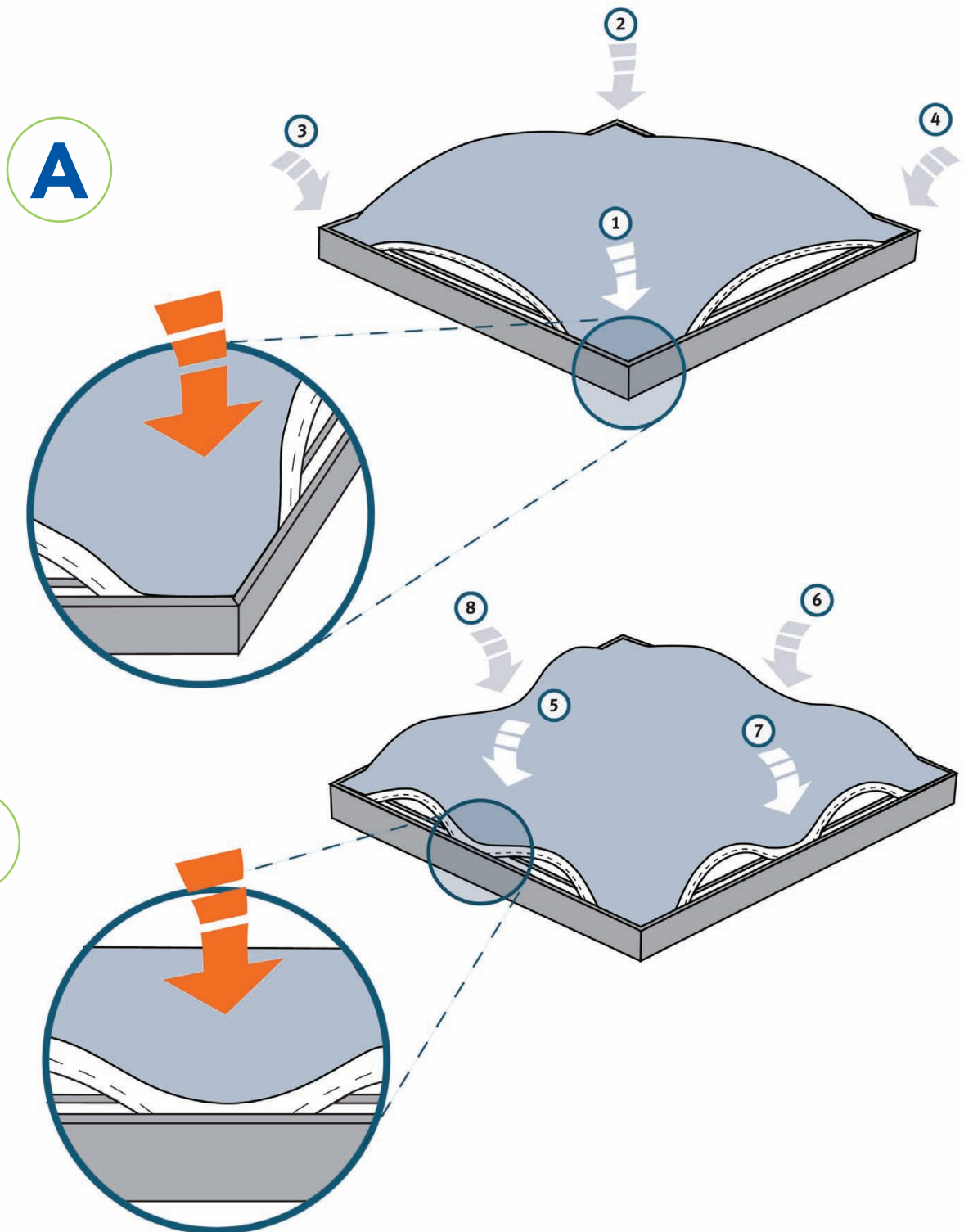

What is SEG **FAQ** ?

Proper installation of an SEG graphic in an extrusion frame.

C

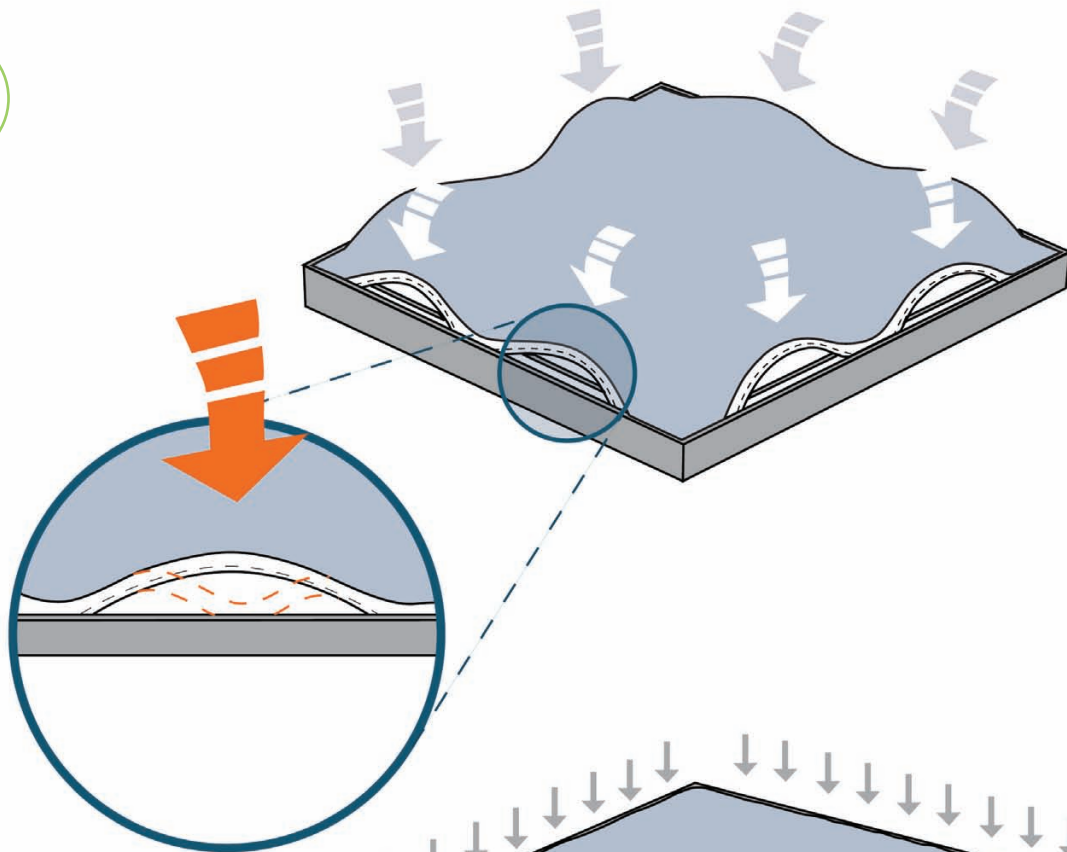

D

