



- 10' wide, 7' deep, 16' tall center tower with locking door, side arches, lights, mounting provisions for monitors

- 5' wide, 5' deep, 4' tall curved kiosks with shelves

- Virtually tool-free assembly

- Finished dimensions
tower with arches:
220" w X 84" d X 185" h
kiosks (each):
62" w X 62" d X 45" h

Please Note: Assembly and graphics installation will require the use of lift, tall ladders, and a crew of several persons

STOP - PLEASE READ:

Before you start frame assembly or installing the fabric/graphic,

PLEASE READ AND FOLLOW ALL INSTRUCTIONS.

When installed correctly, the Panoramic System fabric will not sag or appear out of alignment.

Frame pieces are color coded. Colors correspond to Floor Plan and Frame Detail drawings.

Additional frame markings may be used when necessary.

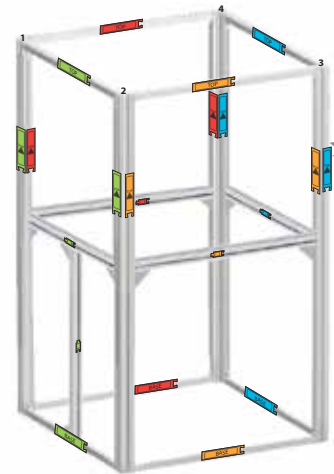

PLEASE NOTE: While the Panoramic frames are durable, they are not indestructible - for the best results, avoid rough handling of the frames, connectors, and end caps.

12 basic colors:

- RED
- LIGHT GRN
- ORG
- LIGHT BLUE
- PURP
- DARK GRN
- TAN
- PINK
- YEL
- WHT
- DARK BLUE
- GRAY

4 types of inserts:

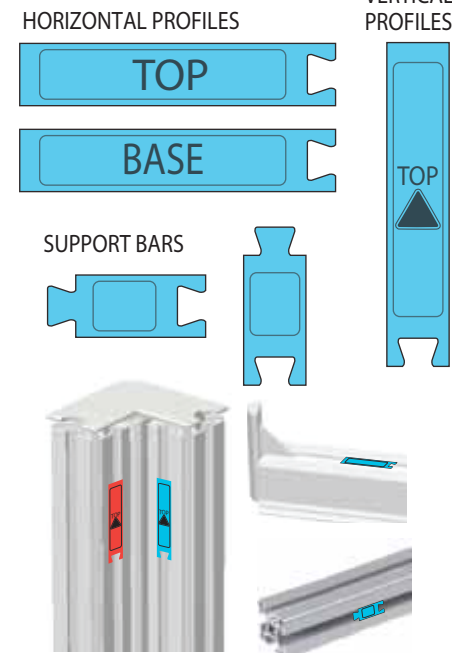

For additional labeling needs, a combination of 2 different colored labels is used.

NOTE: Frame and graphics shown here are for illustration purposes only. Refer to the customized Frame Assembly and Graphics Installation Instructions for your particular Panoramic product.

When assembling the frames, it is very important that the horizontals are properly seated. When properly installed, the grooves in the horizontals will align with the grooves in the end caps.

Proper alignment:

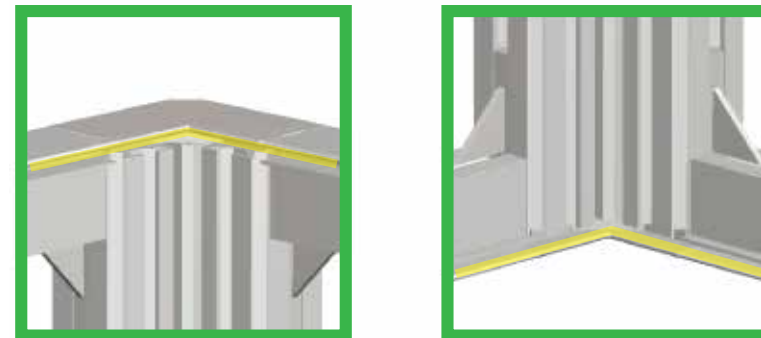

Improper alignment:

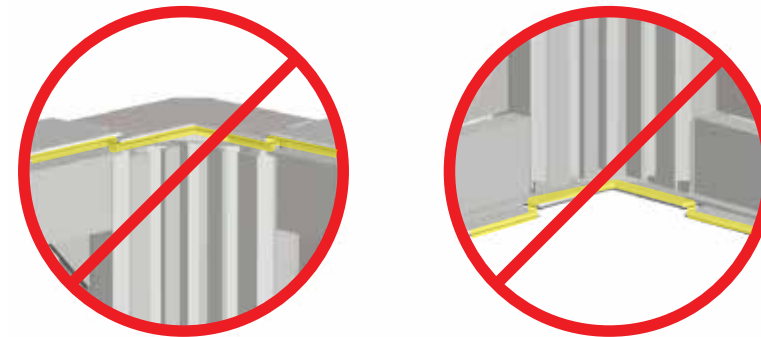

Graphics are identified with a numbered tab in the upper right corner. Numbers correspond to graphics templates shown on Graphics page(s).

Silicone welts go into system grooves at 90° angles as shown below.

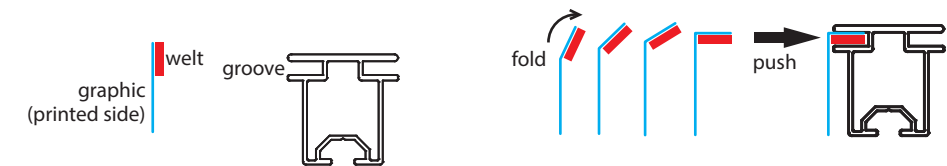

Accurately follow all instructions on Graphics page(s) to insure proper installation.

Graphic assembly instructions and templates follow same color code order (when possible).

Frames will be numbered at all graphic installation points.

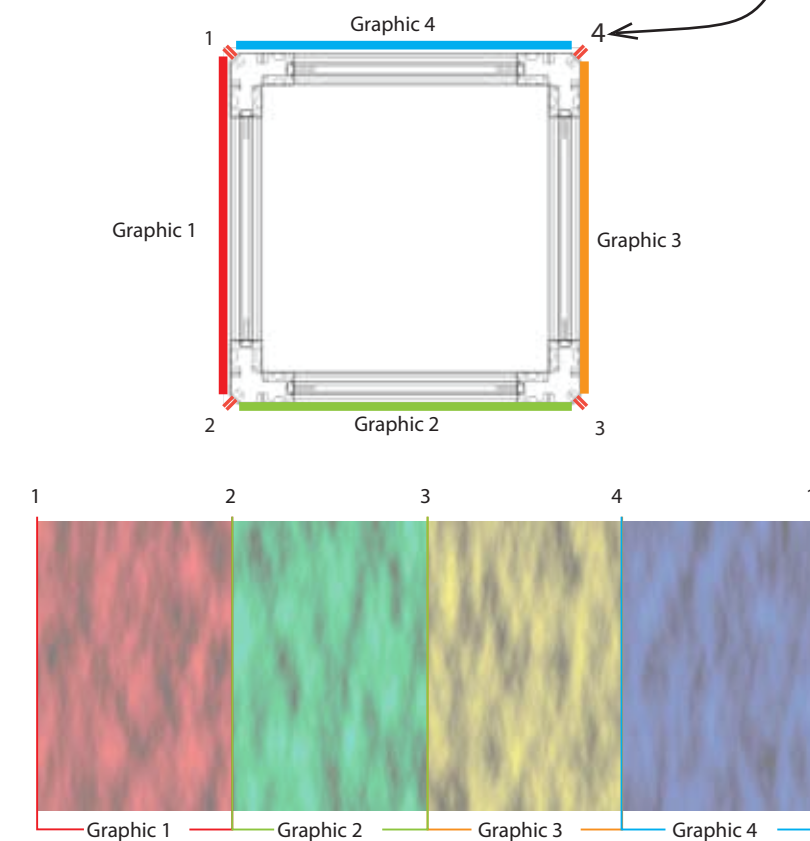

Parts List:

Description	Qty
Pano_A-Frame	8
Pano_C-Frame	20
Pano_I-Frame*	10
Pano_A45-Frame*	12
Pano_F-Frame	76
Support Bar	18
Support Tube	10
Corner Brace	48
Light w adapter	6
Monitor Mount Kit	2
Door	1
Header	1
Shelf	4
Frame	2
Base Plate	4
Link**	6
Joint**	4

*some shipped connected to each other - do not take apart

**shipped installed - do not remove

A - Vertical
8 @ 3.75'



C - Vertical
2 @ 8' • 12 @ 3.75'
2 @ 3.25' • 4 @ 2.75'

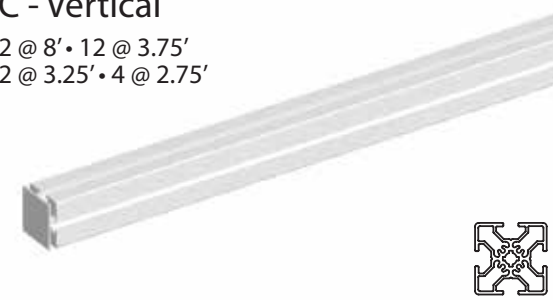

I - Vertical*
2 @ 8'
8 @ 3.25'

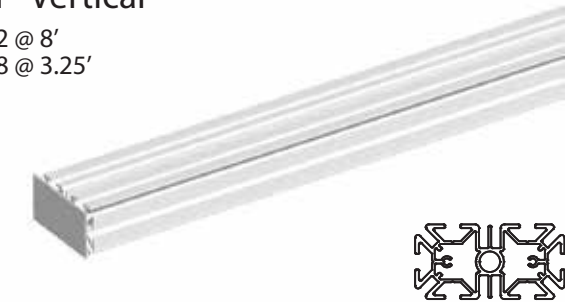

A45 - Vertical*
4 @ 8'
8 @ 3.25'

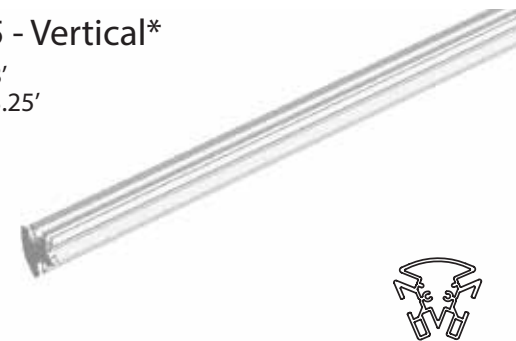

F - Horizontal

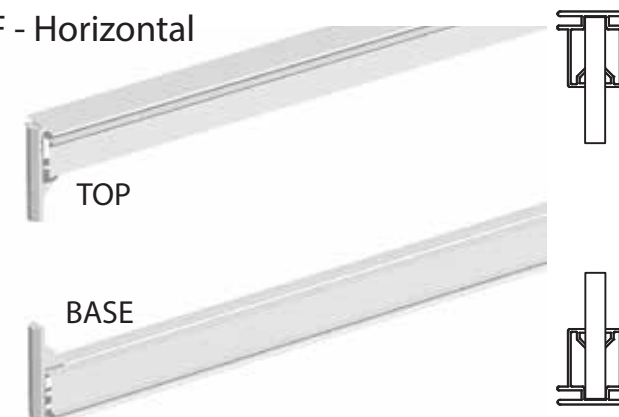

Support Bar
18 pieces



Tools Needed:

For assembly and graphics installation:

- 2.5mm, 3mm, 5mm allen wrench
- ladder or tall step stool

- Assemble bottom, middle, & top sections
- Set middle section onto bottom section, secure using pre-installed links
- Add top section using support tubes
- Connect arches after tower graphics are in place

SEE PAGE 12 FOR ADDITIONAL DETAILS

1: Arrange bottom Pano_F horizontal sections in place. See Floor Plan and Frame Detail pages. Corner connectors will already be in place and sections will be color coded. Bottom horizontal sections have "BASE" printed on their inserts.

2: Place vertical posts down onto corner connectors on horizontal sections. Rotate connector levers up until snug. See Figure 1. Do not over-tighten.

3: Lift connector levers up and slide the top horizontal sections onto the vertical posts. Rotate connector levers down until snug. See Figure 2. Do not over-tighten.

4: Assemble and install door and header according to instructions on page 9.

5: Install supports. See Figure 3.

6: Install lights. See Figure 4.

Please Note: Assembly and graphics installation will require the use of lift, tall ladders, and a crew of several persons

Fig 1:

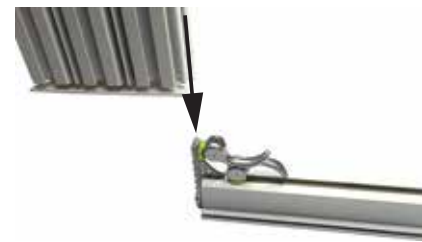

Fig 2:



Fig 3:

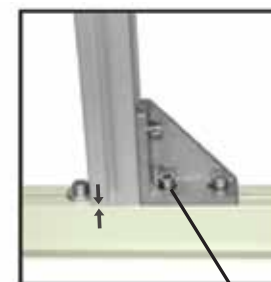
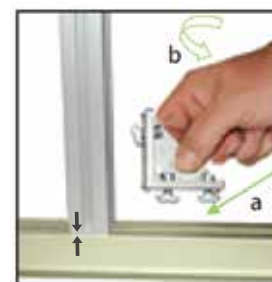
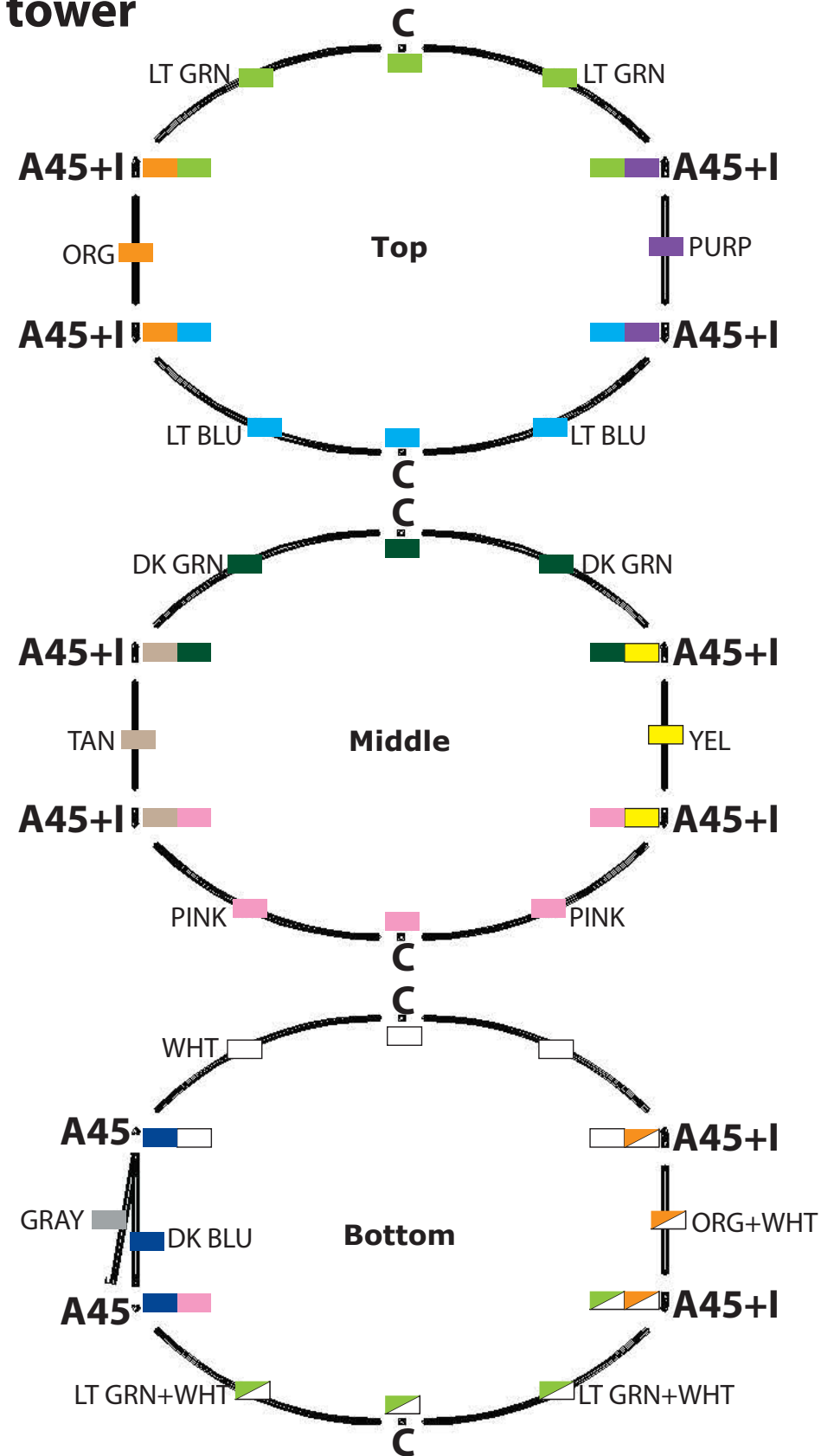

Fig 4:



tower



arch (1 of 2 shown)

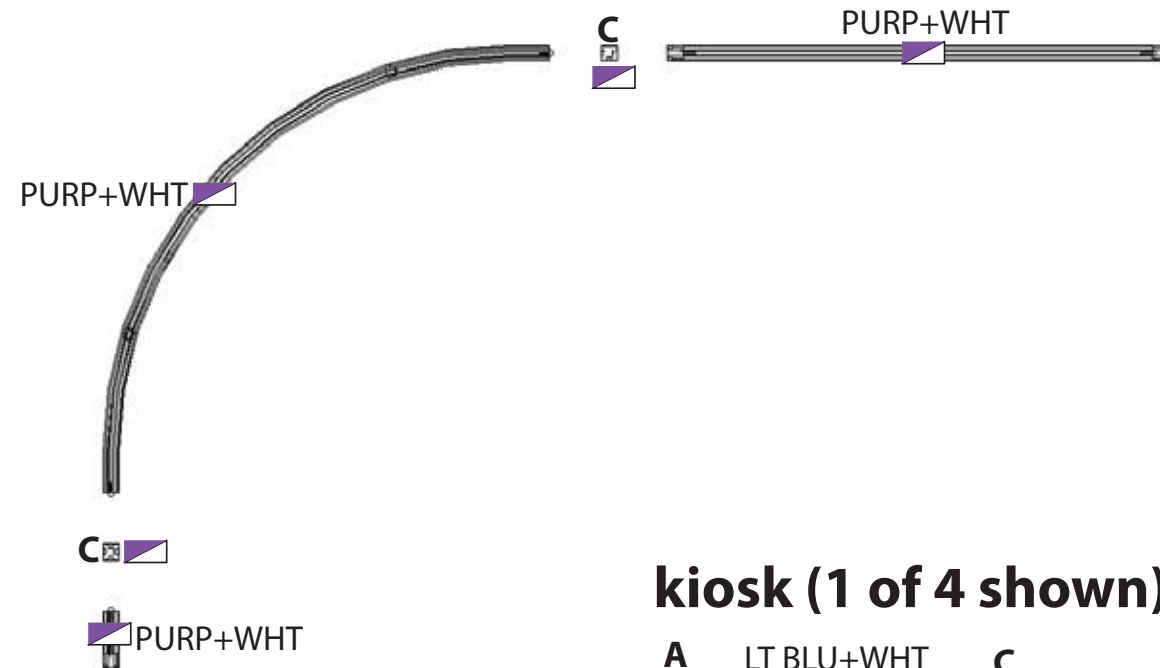

kiosk (1 of 4 shown)

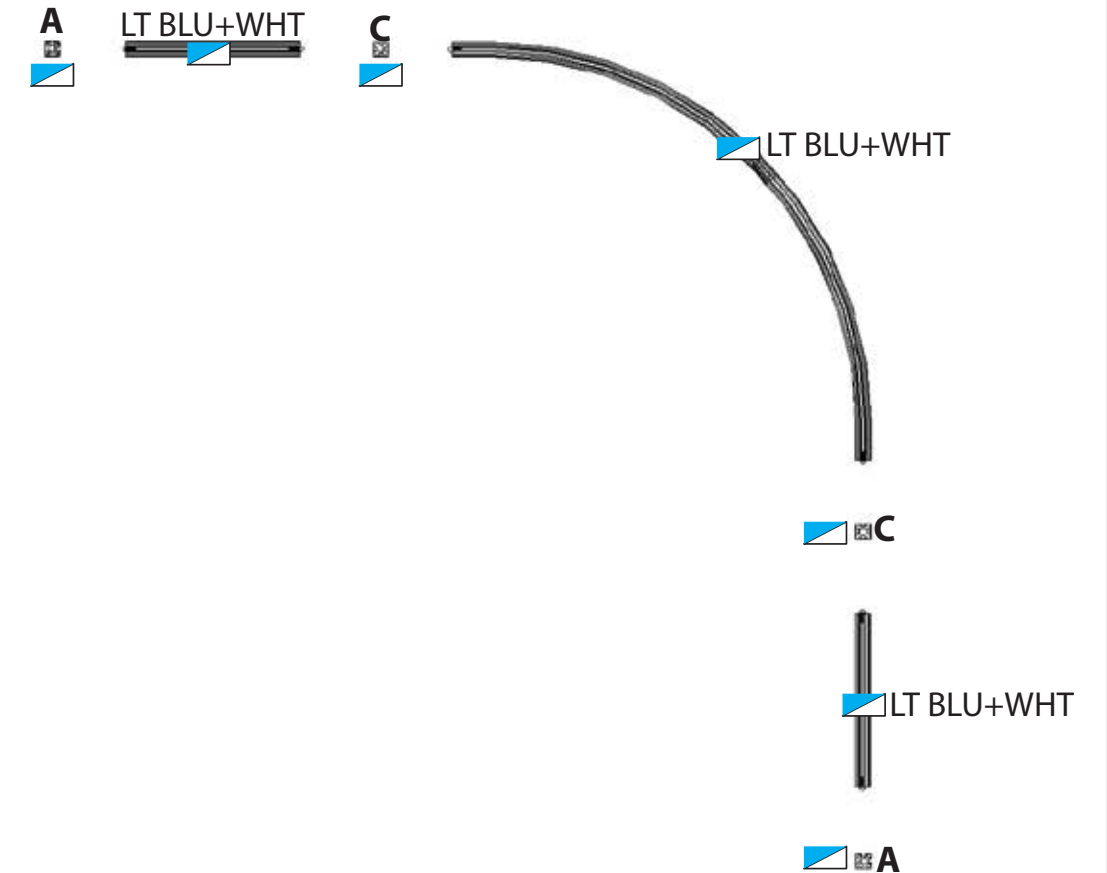

tower

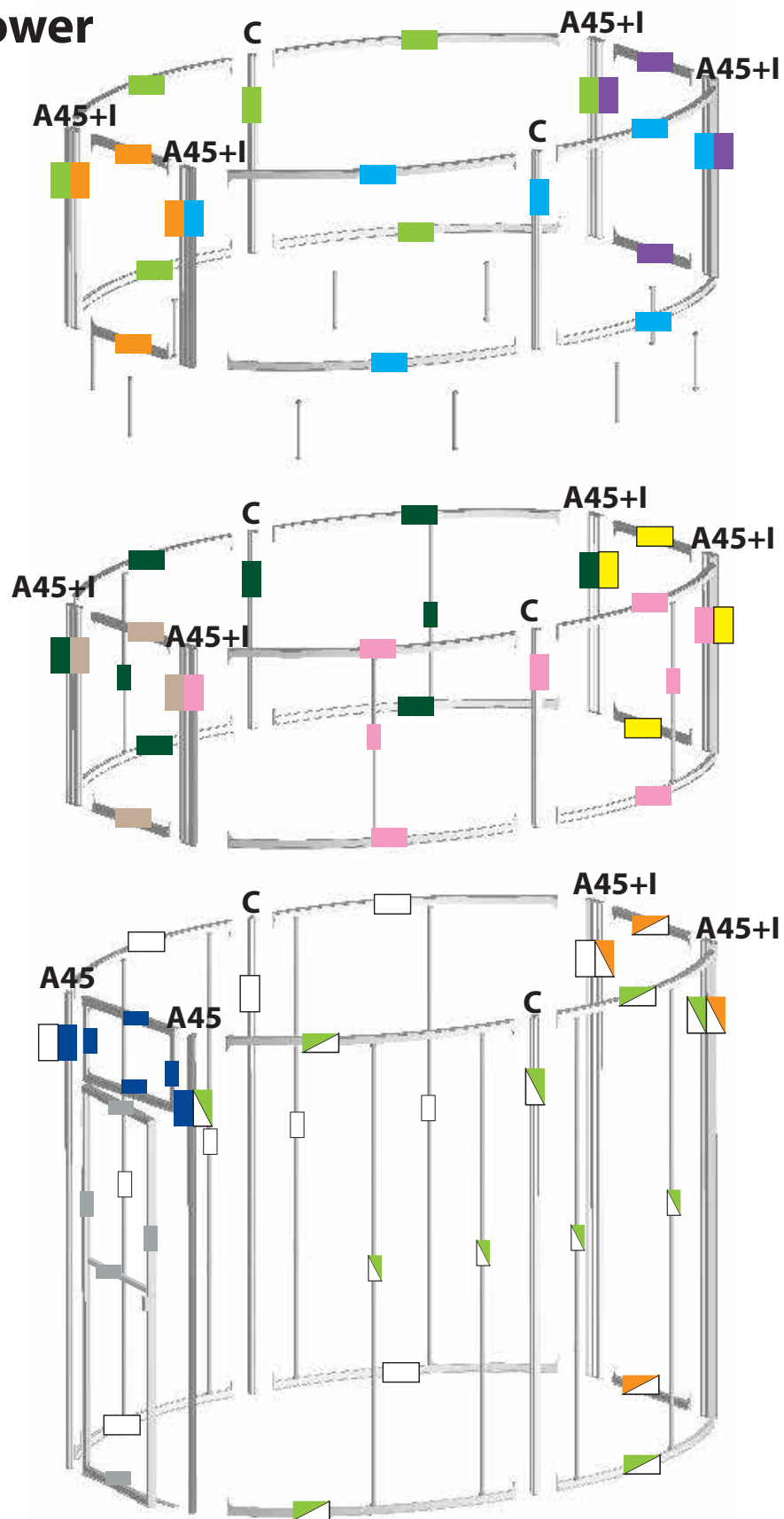

arch (1 of 2 shown)

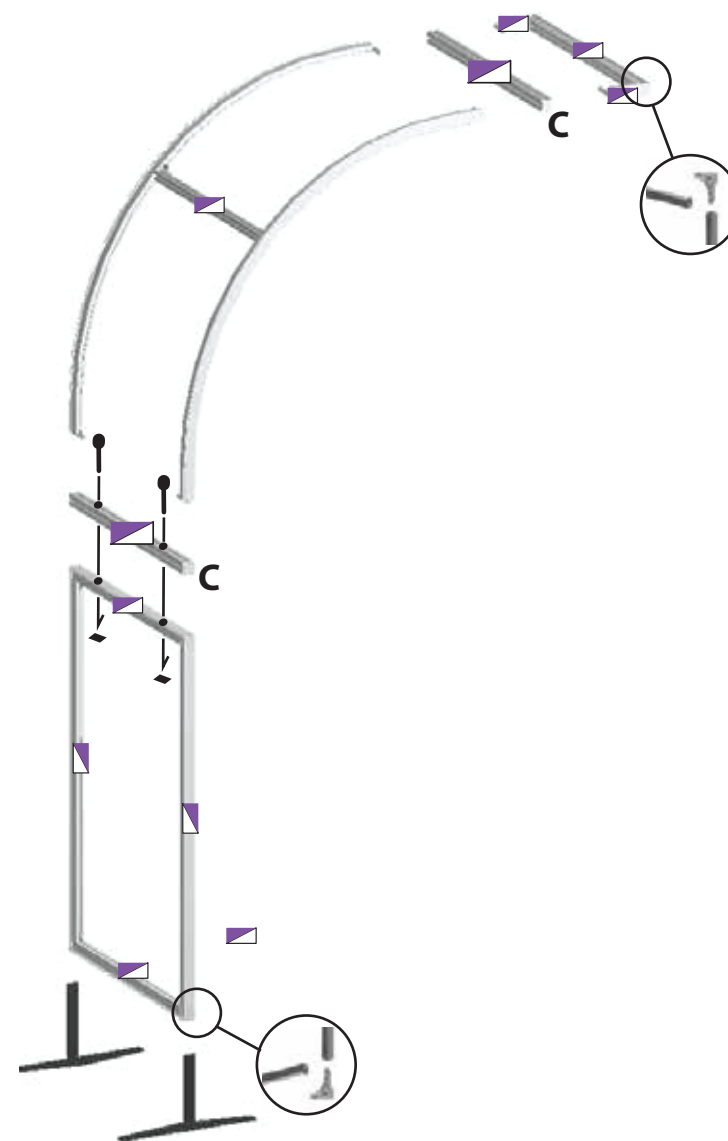

kiosk (1 of 4 shown)

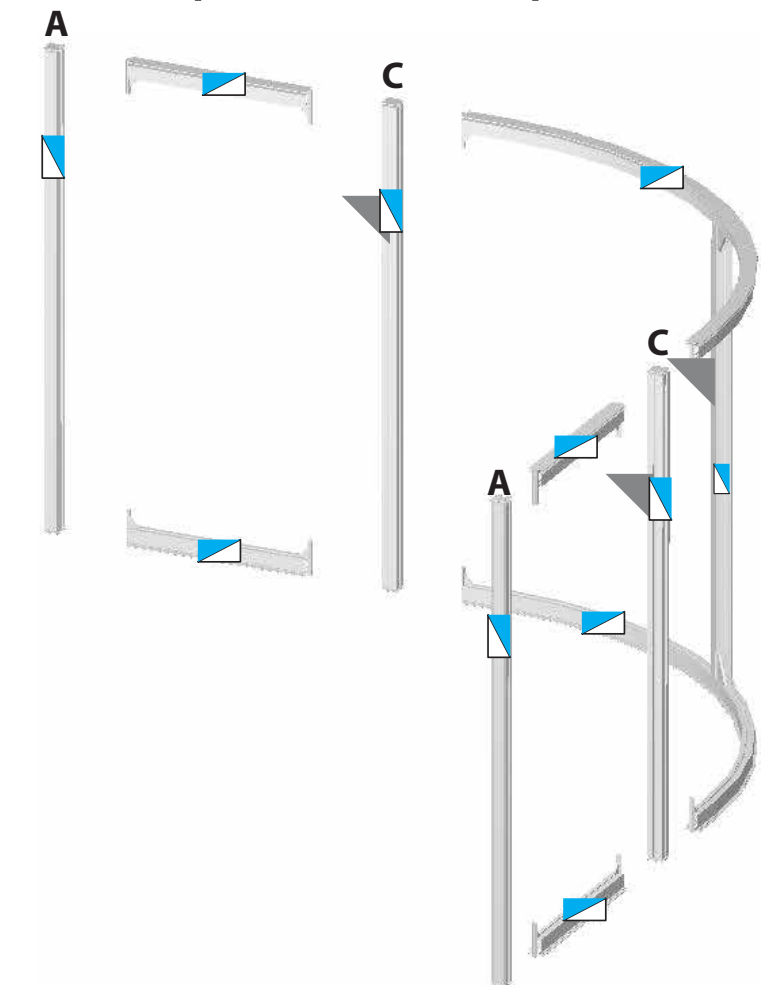

tower

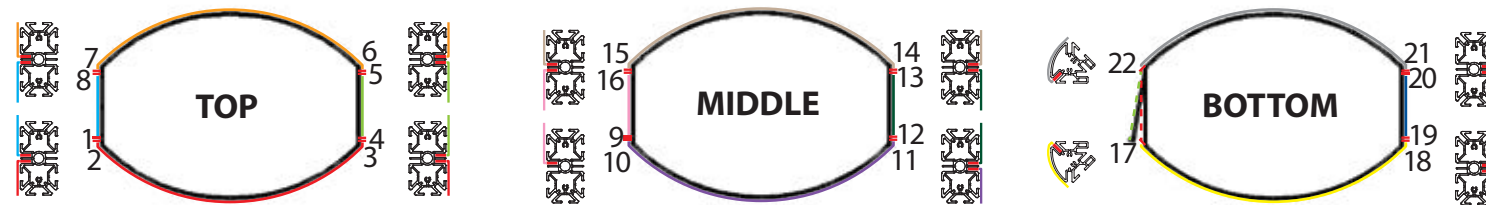

arches

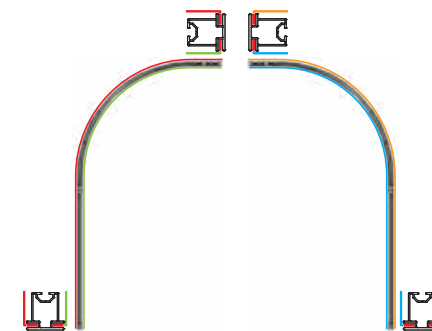

kiosk (1 of 4 shown)

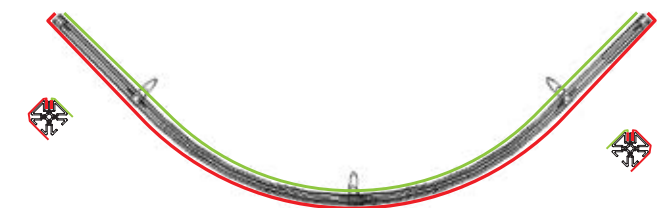

Note: Frame pieces are labeled with colored inserts. Graphic installation points are identified with numbers.

Before installing the graphics:

- Make sure the work area is clean and free of objects which could mar or snag the graphics
- Wear thin gloves and/or use other means to keep the fabric from getting soiled.

Proper installation of the graphics requires following these steps, in order.

Install the graphics one at a time. Fully install the graphics completely along their top and sides before doing any of the bottom edges.

Always start at the ends, then do the middles, then work from the middle out to the ends.

Always **push** the graphics into the grooves, one section at a time - never "slide" the graphics into place.

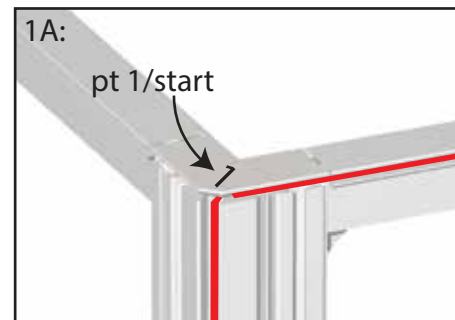

1A: pt 1/start
1: Identify start point on top of frame (shown in 1A) and graphic top left corner with start tab (shown in 1B).

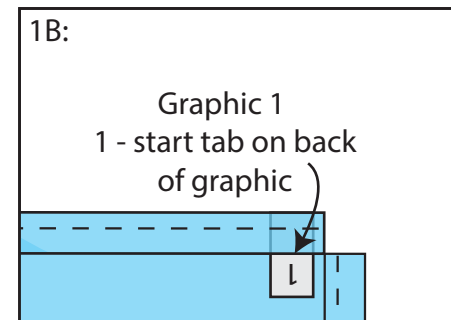

1B: Graphic 1
1 - start tab on back of graphic

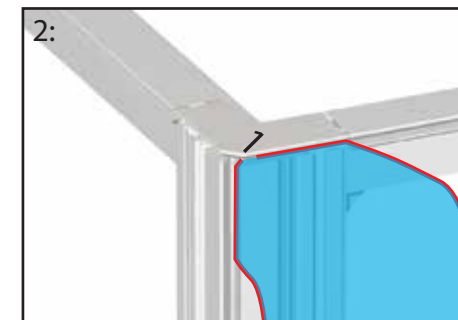

2: Insert top corner of graphic and welt into top groove of vertical at point 1. Align welt on left with vertical groove, insert into groove a few inches.

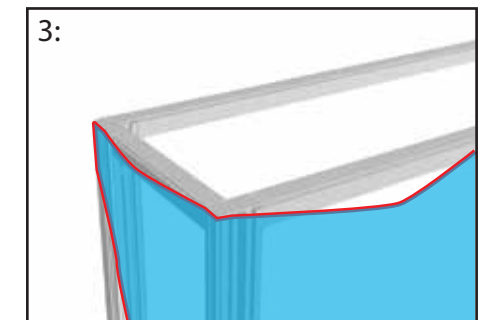

3: Align corners of graphic with corners on frame. Insert top of welt into corners, then insert top right welt a few inches into groove at point 4. Corners must be done first to assure proper fit.

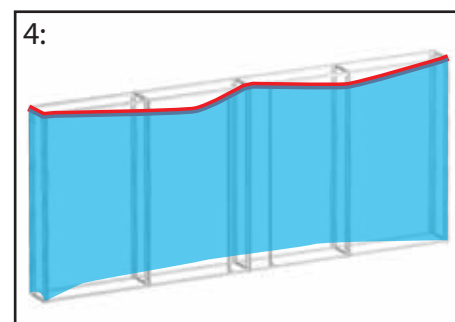

4: Work in top welt between corners from middle out to corners making sure graphic is evenly distributed. Be sure to push the graphic into the groove, not slide.

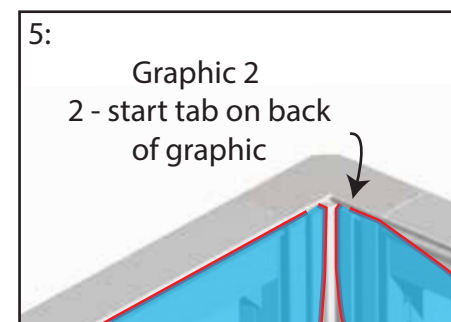

5: For frames with multiple graphics, align the next graphic with the first. Follow steps 1-4 before doing the sides and bottoms.

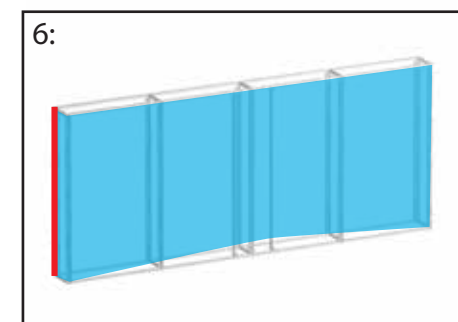

6: Insert welt into vertical grooves between top and bottom corners. Work from middle out, making sure graphic is evenly distributed.

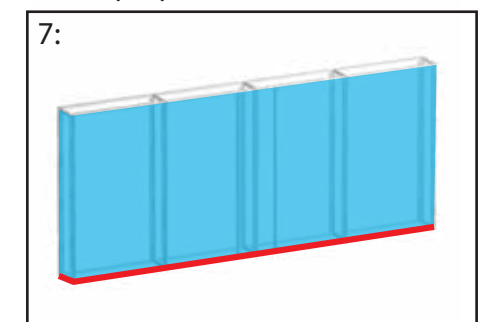

7: Follow steps 1-4 for bottoms of graphics.

tower

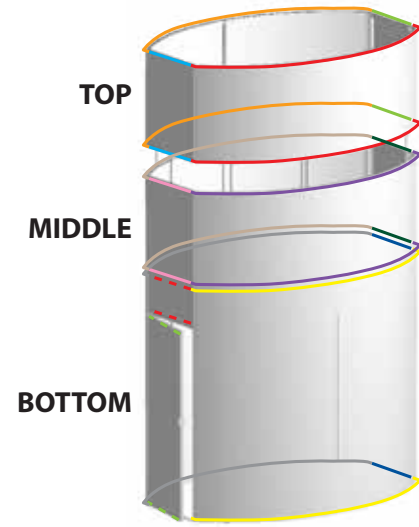

arches

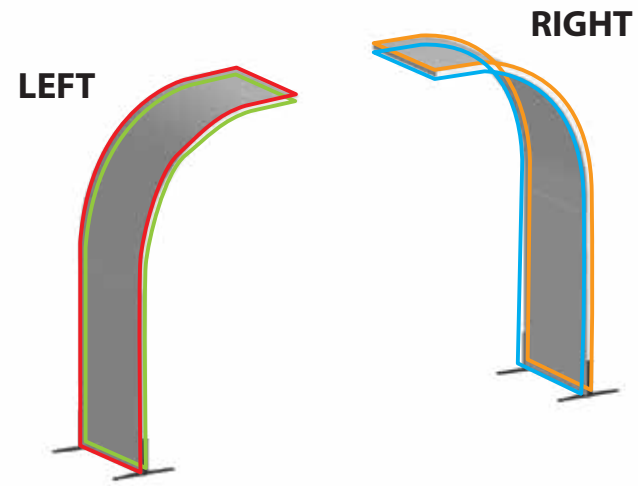

kiosks

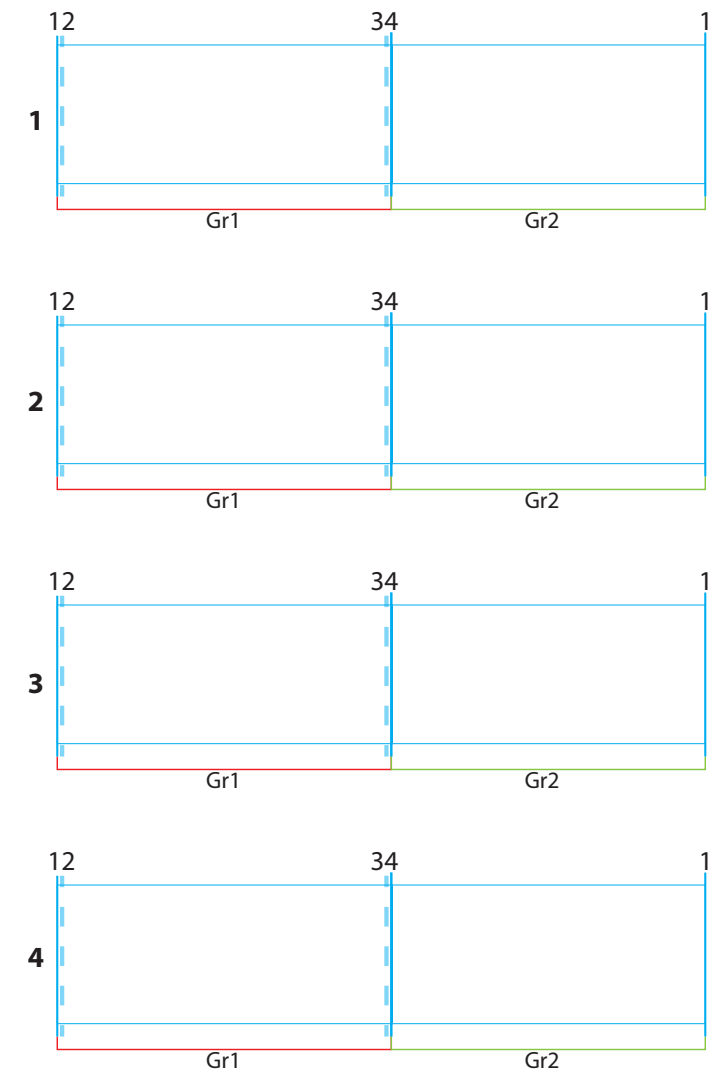
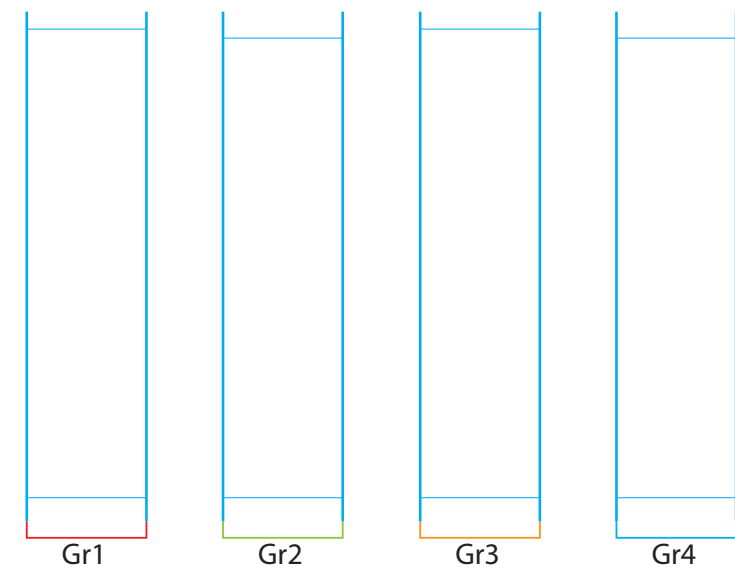
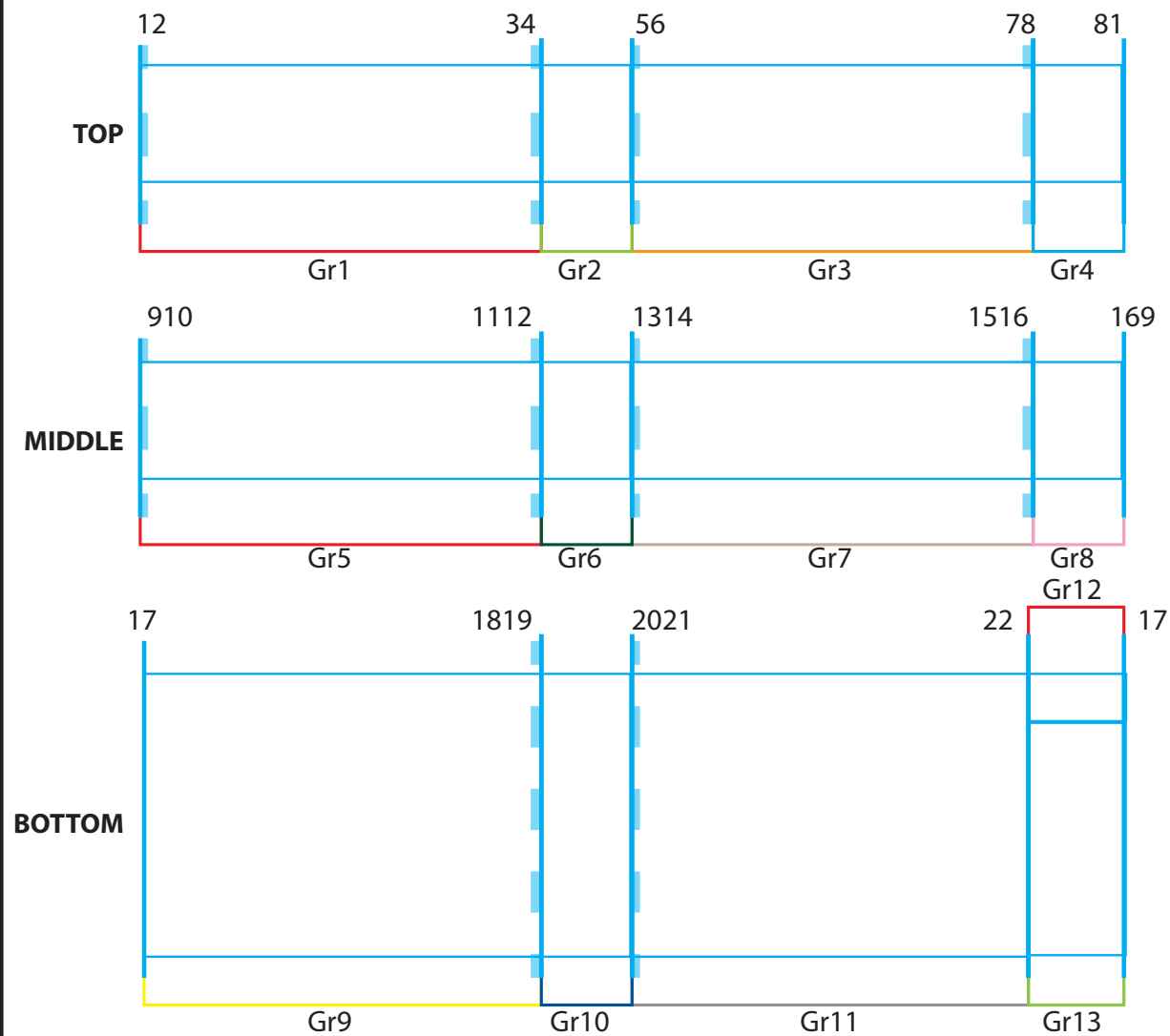

NOTE: images shown are for reference only

PATENT PENDING

Parts List:

Description	Qty
Door:	
Outside corner bracket	4
Threshold with L-connectors*	1
Locking door handle	1
Cable with adjustable clamps	1
Turnbuckle	1
Hinges	2
Pano_F-Frame	4
Support bar	1
Header:	
Outside corner bracket	4
Pano_F-Frame	4
Long t-nut screws	4

Install graphics on frame that the door is attaching to before installing the door on frame to install.

. Follow pictorial for door assembly. Match hinges on door to hinges

Header may be shipped pre-assembled. Assemble header as shown if needed. Use long t-nut screws to attach header to frame.

Door:

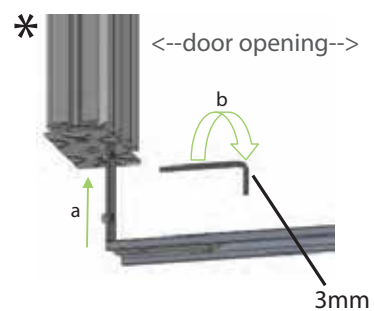
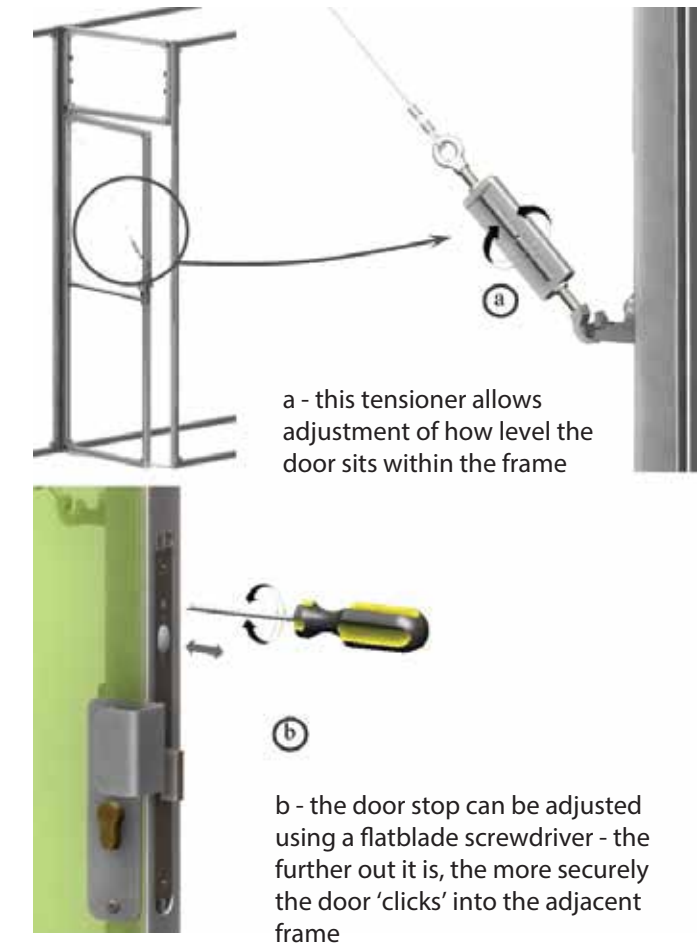

disregard non-applicable door assembly steps

Header:



DETAIL 1:



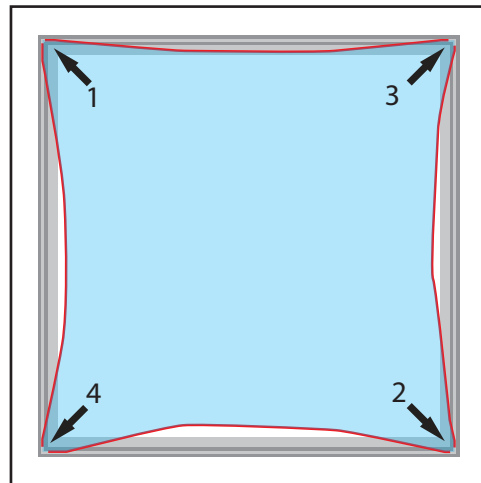
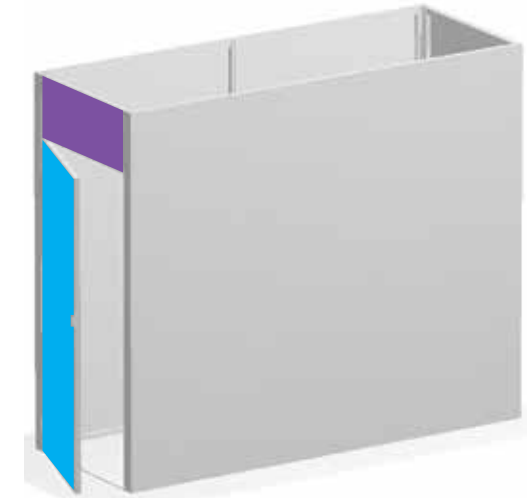
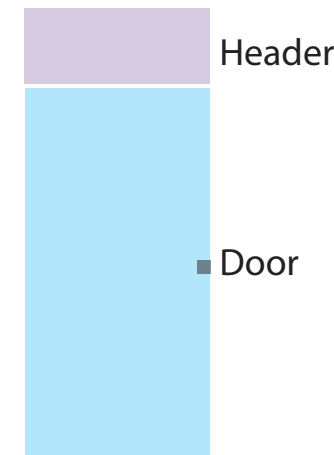
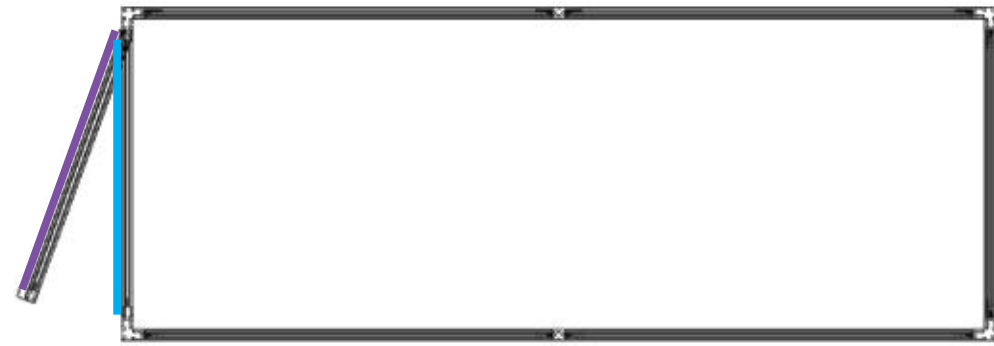

NOTE: It is important to first insert the graphic into each alternate corner, then into the sides of the frame. If this is not done, the graphic will not fit properly in the frame.

Always push the graphics into the frame, one section at a time - do not slide them into place.



1: Insert top left corner of graphic into the frame. Turn edge of graphic so welt is perpendicular to face of graphic. Insert narrow side of welt with fabric towards the outside into the groove. Repeat for the bottom right corner.



2: Repeat Step 1 for the top right and bottom left corners.

Corners must be done first to insure proper graphic installation.



3: Once the corners are inserted, press the middle of the welt into the groove, then work out to the corners, pressing one section in at a time. Make sure welt is fully inserted into groove. Continue until all sides are done. Smooth out edges of graphic.

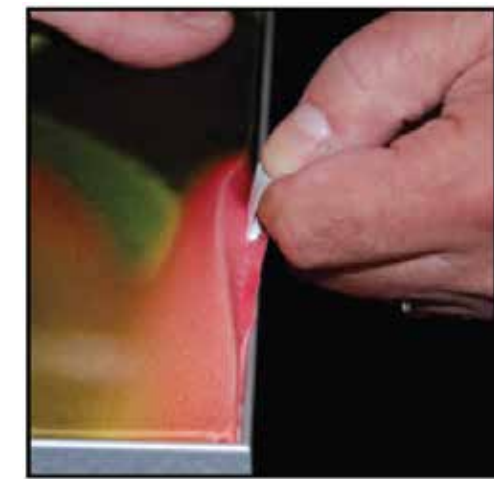

To remove the graphic from the frame, locate the fabric pull tab. Gently pull up on the tab to remove the graphic.

Parts List:

Description

Monitor Mount



Support Bar



Corner Bracket



Hex Cap screws

Washers

1: *The support bars and corner brackets should already be in place. If not, refer to Basics for installation instructions.

NOTE: Install the supports before installing the graphics. Install graphics on the side of the frame that the monitor is attaching to before installing the monitor mount.

2: Level the wall plate and align with the pre-installed link plates in the supports. Thread Hex Cap screws through washers and mount hardware. Insert into link plates and tighten until snug.

3: Install balance of graphics on frame.

4: Follow instructions from monitor mount manufacturer to attach hardware to monitor and then to mount.

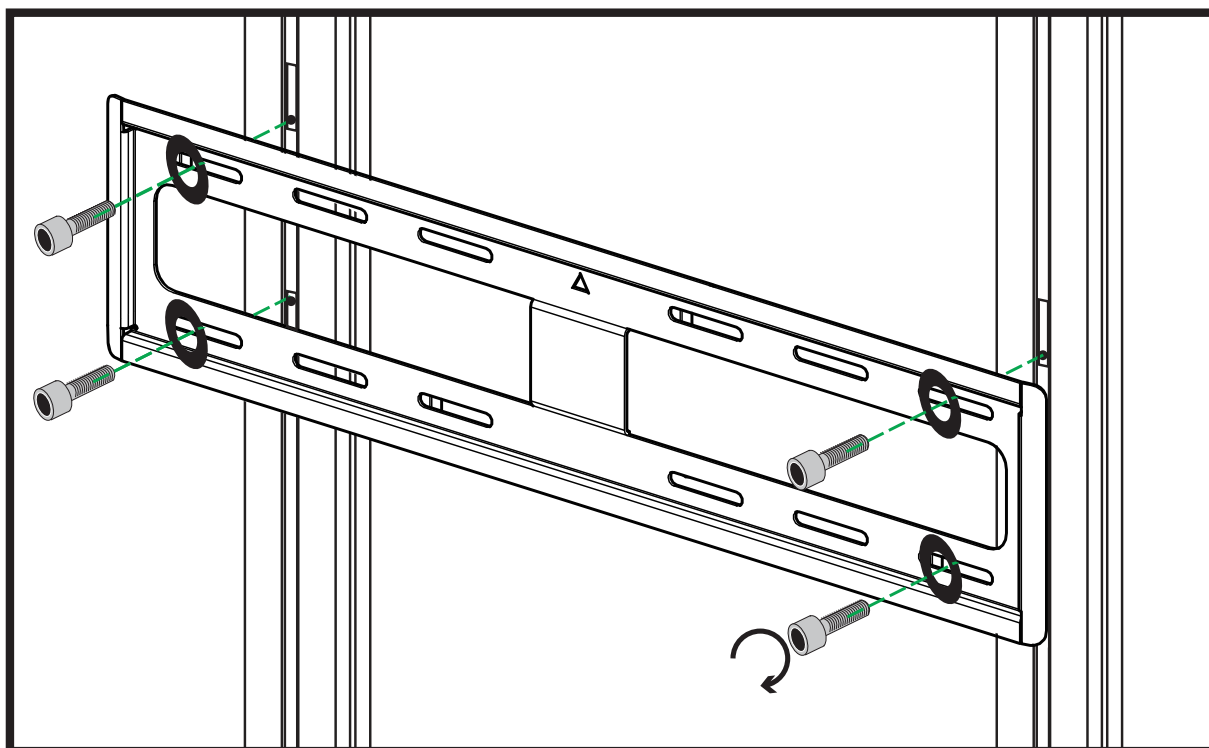

NOTE: mounts and supports may vary from those shown
See instructions in mounting kit(s) for additional information

attach top section using supports tubes

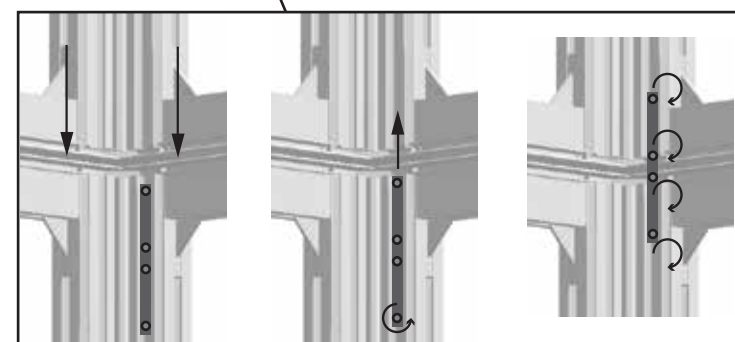
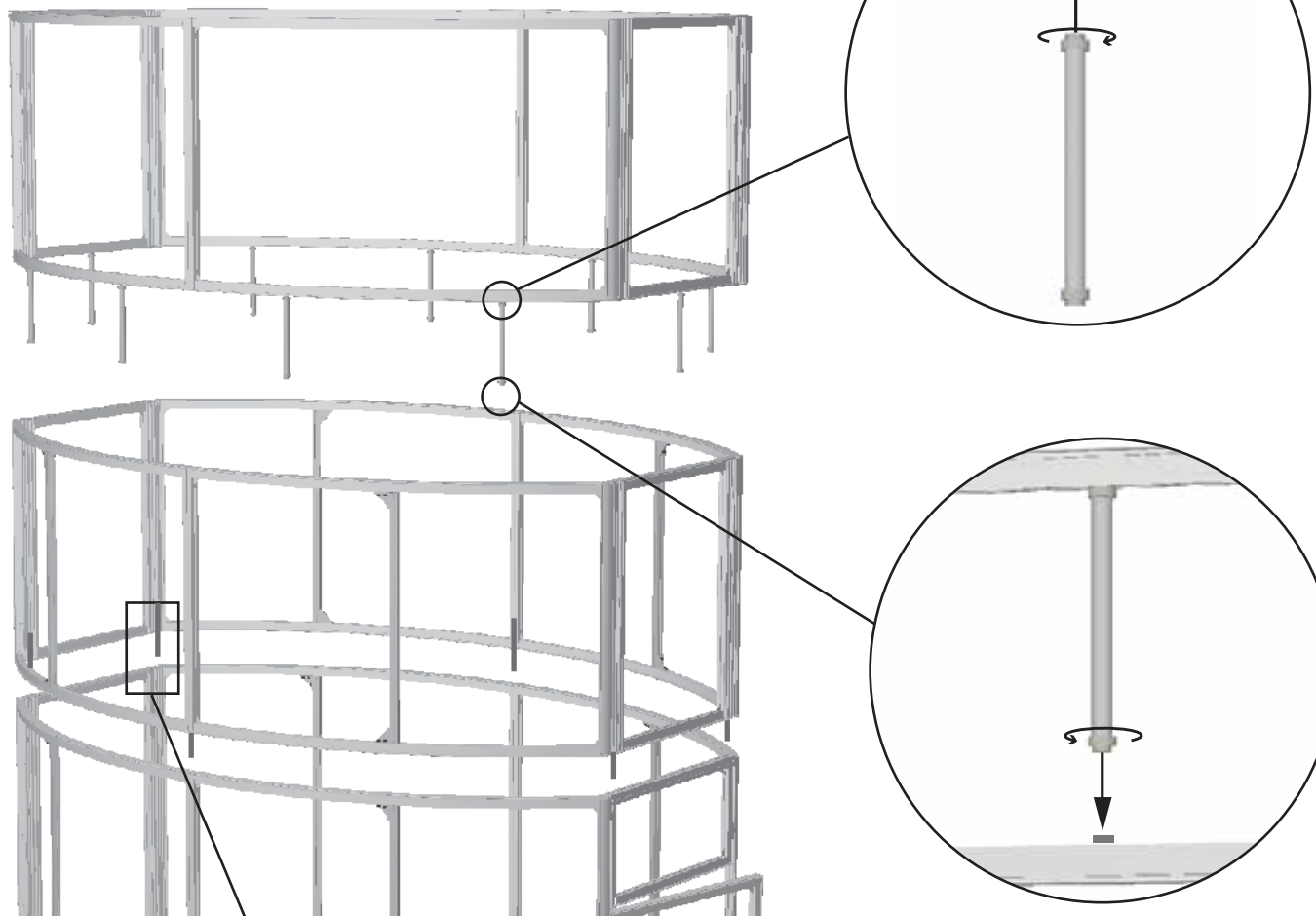

attach middle section to bottom section using pre-installed links

attach arches to tower using bolts

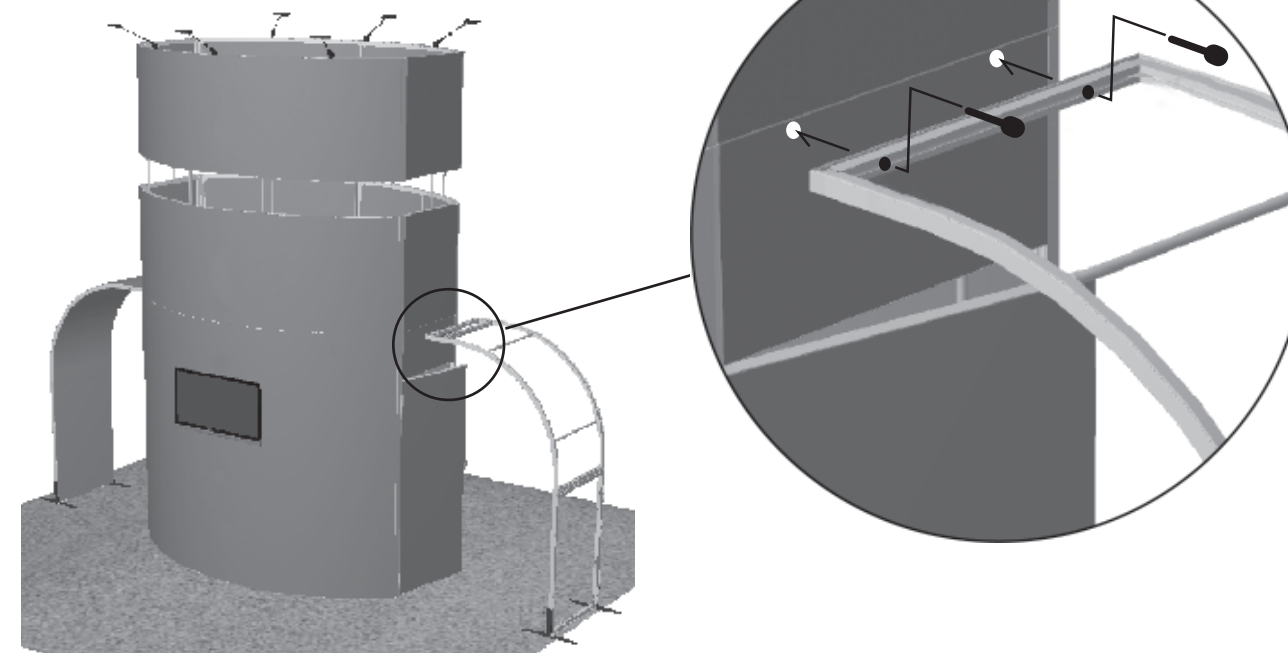

install tower graphics *before* attachment, arch graphics *after* attachment

attach shelves to kiosks using short screws

